

Makro-Grip® FS 125, 5-Axis Vise

Jaw width 125 mm, Clamping range 0 - 155 mm, with continuous / full serration

Item No. 48155-125 FS



Clamping range	0 - 155 mm (0" - 6.1")
Dimensions	160 x 125 x 89 mm (6.3" x 4.92" x 3.5")
Clamping method	by form-fit / by friction
Workpiece shape	prismatic
Packaging Unit	1 Piece
Weight	8.3 kg (18.3 lbs)
Material	Steel

Makro-Grip® FS 125, 5-Axis Vise

Jaw width 125 mm, Clamping range 0 - 155 mm, with continuous / full serration

Item No. 48155-125 FS

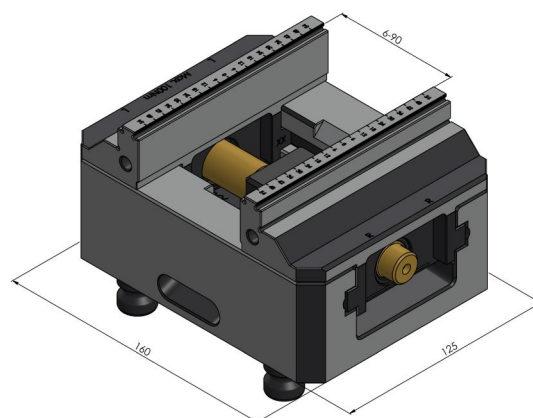
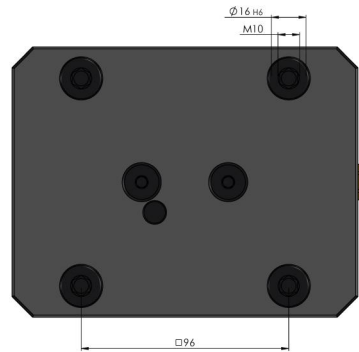

Makro-Grip® FS 125, 5-Axis Vise

Jaw width 125 mm, Clamping range 0 - 155 mm, with continuous / full serration

Item No. 48155-125 FS

