

Makro-Grip® FS 77, 5-Axis Vise

Jaw width 77 mm, Clamping range 0 - 200 mm, with continuous / full serration

Item No. 48200-77 FS

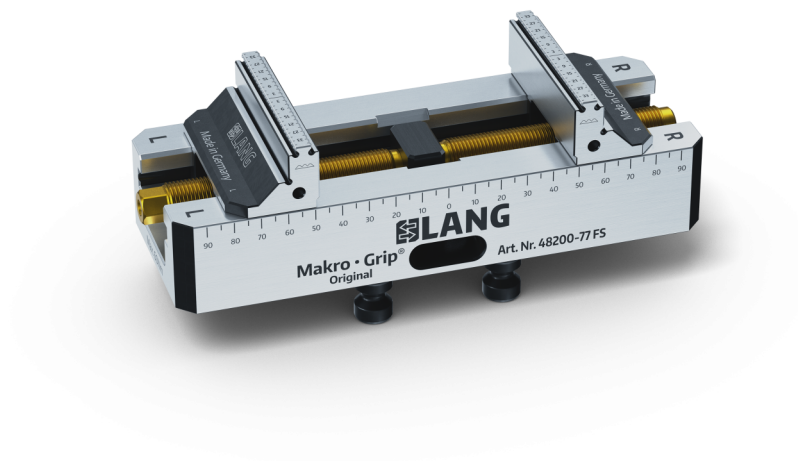

Clamping range	0 - 200 mm (0" - 7.87")
Dimensions	210 x 77 x 65 mm (8.27" x 3.03" x 2.56")
Clamping method	by form-fit / by friction
Workpiece shape	prismatic
Packaging Unit	1 Piece
Weight	4.2 kg (9.26 lbs)
Material	Steel

Makro-Grip® FS 77, 5-Axis Vise

Jaw width 77 mm, Clamping range 0 - 200 mm, with continuous / full serration

Item No. 48200-77 FS

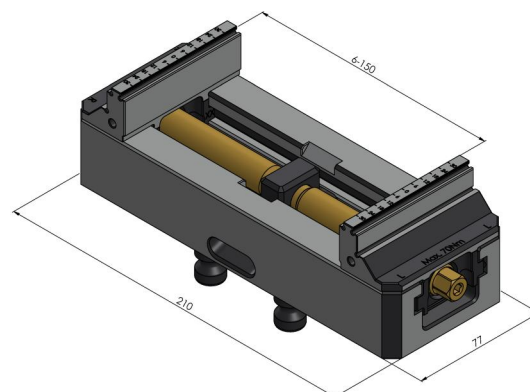
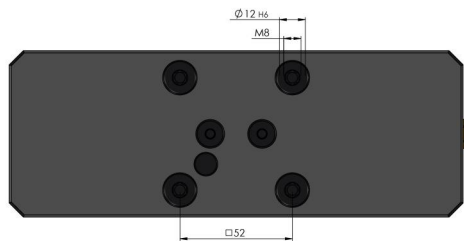

Makro-Grip® FS 77, 5-Axis Vise

Jaw width 77 mm, Clamping range 0 - 200 mm, with continuous / full serration

Item No. 48200-77 FS

