

Makro-Grip® 46, 5-Axis Vise

Jaw width 46 mm, Clamping range 0 - 65 mm

Item No. 48065-46



Clamping range	0 - 65 mm (0" - 2.56")
Dimensions	77 x 77 x 65 mm (3.03" x 3.03" x 2.56")
Clamping method	by form-fit / by friction
Workpiece shape	prismatic
Packaging Unit	1 Piece
Weight	1.75 kg (3.86 lbs)
Material	Steel

Makro-Grip® 46, 5-Axis Vise

Jaw width 46 mm, Clamping range 0 - 65 mm

Item No. 48065-46

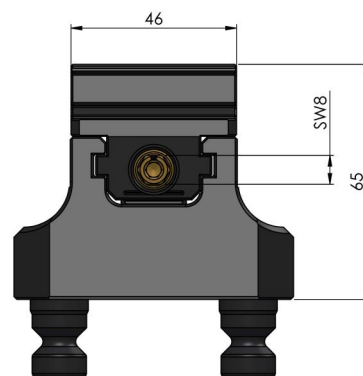
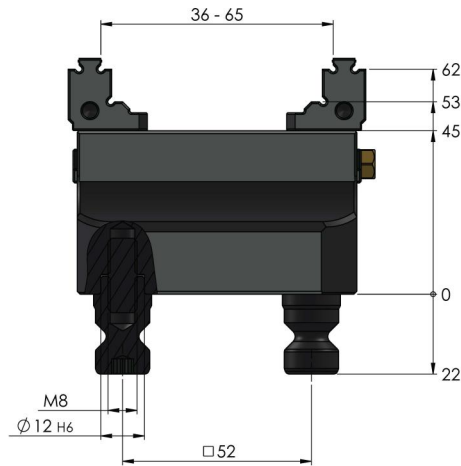

Makro-Grip® 46, 5-Axis Vise

Jaw width 46 mm, Clamping range 0 - 65 mm

Item No. 48065-46

