

Abmessungen	Backenbreite: 77 mm - Backenlänge: 28 mm - Backenhöhe: 30 mm
Bauteilform	kubisch / zylindrisch / asymmetrisch
Verpackungseinheit	1 Paar
Gewicht	0.28 kg
Material	Aluminium

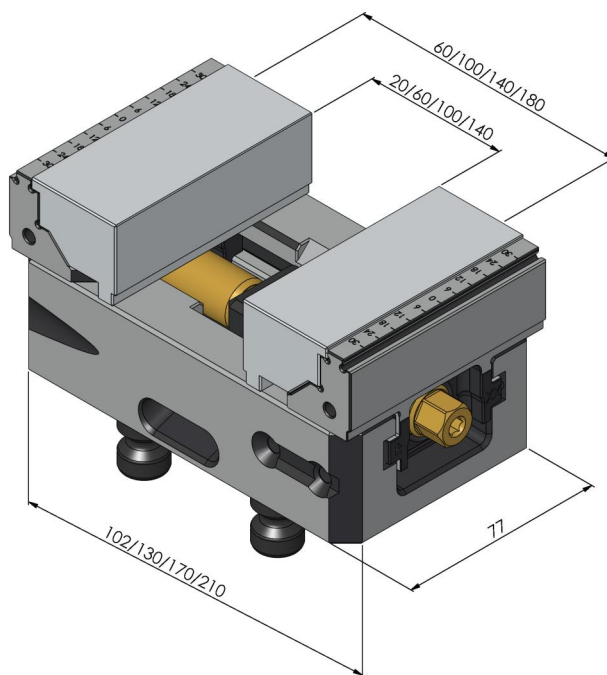

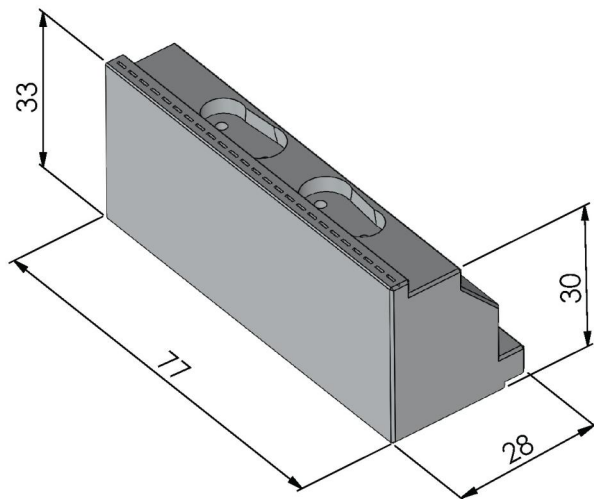

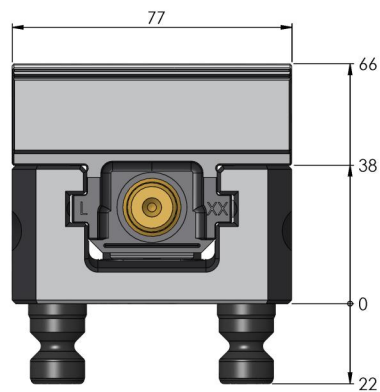
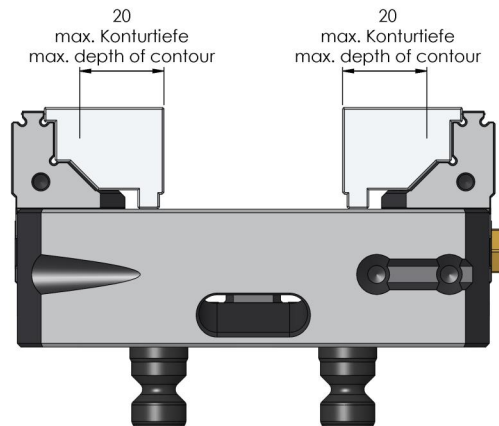
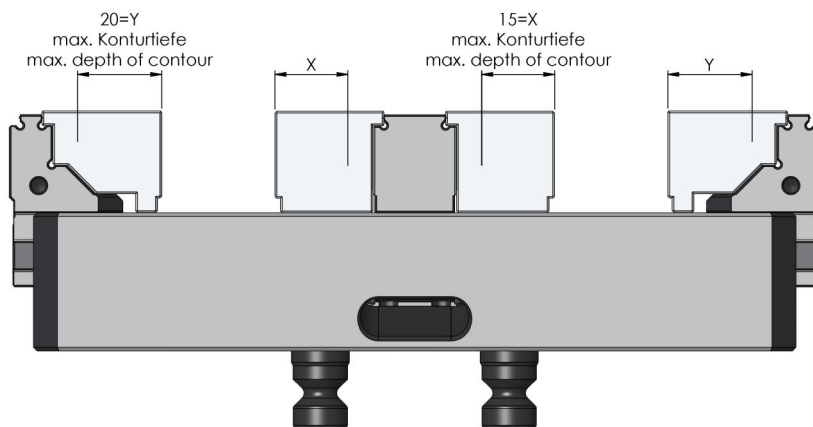
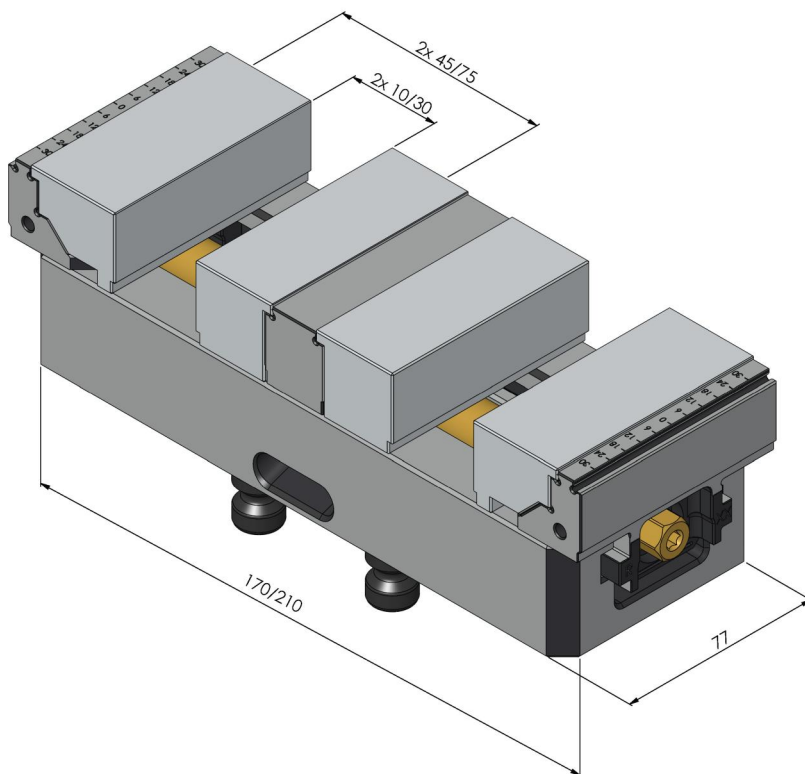

Makro-Grip® 77, Konturbacken

Backenbreite 77 mm, für die Außenseite

Item No. 48419-77

