

Quick-Point® 52, lápida de 4 caras

192 x 192 x 260 mm

Item No. 70264

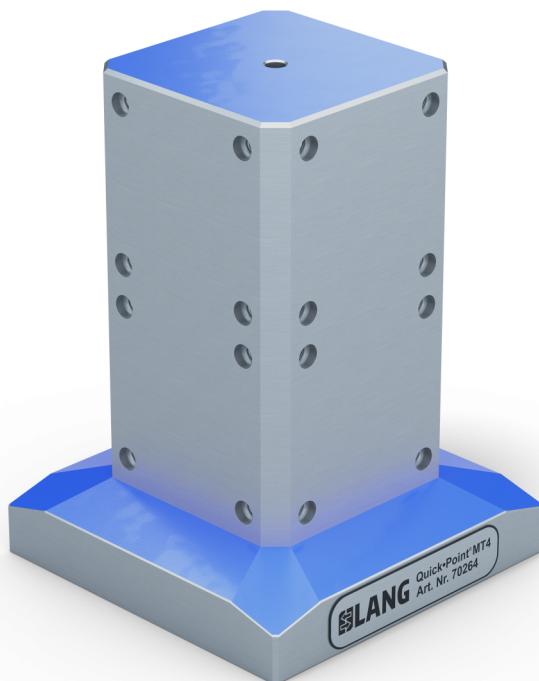

Dimensiones cuerpo	125 x 125 mm
Dimensiones pie	192 x 192 mm
Altura total	260 mm
Placas de matrícula	8 x 75600 / 4 x 45621
Tipo de máquina	VMC / HMC
Unidad de envasado	1 Pieza
Peso	37.1 kg
Material	Acero

Quick-Point® 52, lápida de 4 caras

192 x 192 x 260 mm

Item No. 70264

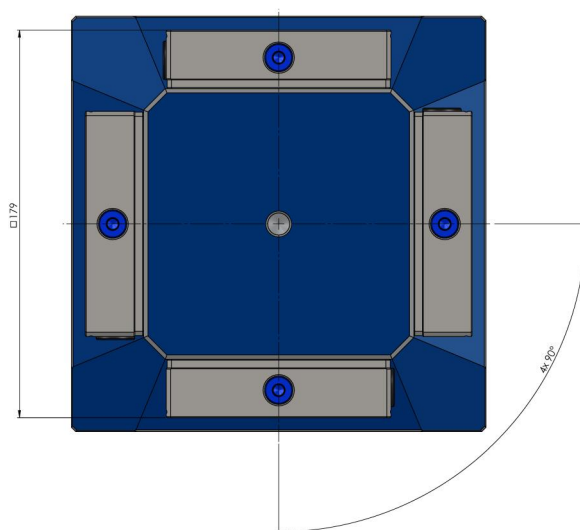
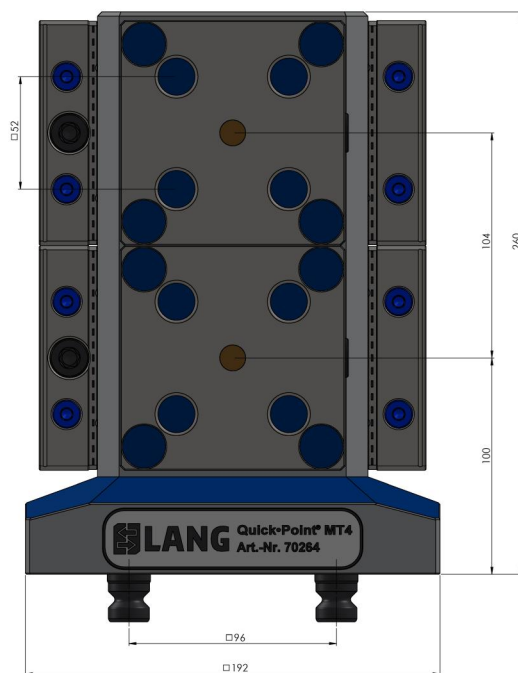

Quick-Point® 52, lápida de 4 caras

192 x 192 x 260 mm

Item No. 70264

