

# Instructions for Use

*MANUAL*

Originalanleitung

## **Makro·4Grip® Rundteilspannung** Makro·4Grip round part clamping



**Spannbacken**  
Clamping Jaws



**Prägebacken**  
Stamping Jaws

## Imprint

---

Version: 2021/58  
Copyright:  
LANG Technik GmbH  
Albstraße 1–6  
Germany  
D-73271 Holzmaden

Tel.: +49 7023/9585-0  
Fax: +49 7023/9585-100  
info@lang-technik.de  
www.lang-technik.de

*This document contains instructions and information that may not be duplicated, distributed or transferred/transmitted as electronic data or used for competitive purposes, neither in full nor partially, without prior authorisation. Errors or omissions in the document excepted. All rights to this document are retained by LANG Technik GmbH.*

*Changes to the product: If changes are made to the product by the customer the guarantee is cancelled. No changes may be made to the product without the prior approval of the manufacturer.*

*Use original spare parts only. If third-party parts are used, there is no guarantee that they have been designed and produced for the necessary loads and stresses, and safety requirements. The manufacturer provides the full guarantee only and exclusively for spare parts ordered from them.*

*The manufacturer endeavours to improve their products. They reserve the right to make changes. There is no associated obligation to subsequently adjust already delivered products.*

*General terms and conditions of sale and delivery:  
Our general terms and conditions of sale and delivery apply. These are available to the owner/operating company for the conclusion of the contract at the latest.*

*Warranty and liability claims for personal injuries and damage to property are excluded if they are due to one or several of the following causes:*

- *Improper use*
- *Improper installation, commissioning, operation and maintenance*
- *Operating the product in a defective condition*
- *Poor monitoring of parts that are subject to wear*
- *Disregard of the instructions and information in the documentation*
- *Disasters caused by the effect of foreign bodies and force majeure*

# Table of Contents

---

<b>1</b>	<b>About these Operating Instructions</b>	<b>4</b>
1.1	The design of the warnings	4
<b>2</b>	<b>Safety Instructions</b>	<b>5</b>
2.1	Intended use	5
2.2	Improper use	5
2.3	Operating personnel requirements	5
2.4	Personal protective equipment and safety of persons	6
2.5	Improper handling is ...	6
2.6	Working environment	7
2.7	Transport and storage	7
2.8	Disposal	7
<b>3</b>	<b>Product Description</b>	<b>8</b>
3.1	General product description	8
3.2	Scope of supply of the clamping jaws and scope of supply of the stamping jaws	8
<b>4</b>	<b>Installation of the Makro·4Grip Stamping Jaws on the Stamping Station</b>	<b>9</b>
4.1	Dismantling/mounting the base jaws on the stamping station	9
4.2	Dismantling/mounting and moving the stamping inserts	10
<b>5</b>	<b>Installation on the Central Clamp</b>	<b>11</b>
5.1	Changing the clamping jaws	11
5.2	Dismantling Makro·Grip clamping jaws	11
5.3	Mounting Makro·4Grip clamping jaws	11
<b>6</b>	<b>Notes and Data for Setting Up</b>	<b>12</b>
6.1	Selecting the suitable clamping jaws according to the workpiece diameter	12
6.2	Positioning of the stamping inserts based on the clamping jaw type	14
6.3	Tightening torques of the mounting screws in the stamping jaws	14
<b>7</b>	<b>Stamping and Clamping</b>	<b>15</b>
7.1	Illustration of a model stamping	15
7.2	Example combination of stamping and clamping devices	16
7.3	Exemplary example settings at the stamping station	16
7.4	Tightening torque at the clamping screw of the central clamp	16
<b>8</b>	<b>Spare parts</b>	<b>17</b>
8.1	Stamping	17
8.2	Clamping	17
<b>9</b>	<b>Dimensions</b>	<b>18</b>

# 1 About these Operating Instructions

The instructions contain important information for safe and proper handling of the product.



**Keep these instructions for later reference**

In these instructions the retooling kit is also called the “product”.

- Only use the product if you have read and understood these operating instructions in full! This also applies to the instructions of the machines/clamping device in which the product is used.
- The instructions are part of the product and must be kept accessible to the personnel at all times.
- Product damage and defects must be reported to the owner/operating company immediately and repaired by skilled personnel without delay, in order to limit the extent of the damage and to ensure that there are no negative effects on the safety of the user and of the product.
- Always familiarise yourself also with the function and safety instructions of the stamping station: See “Stamping station (41200/41350/41521/41400/41140/41402)” operating instructions.

## 1.1 The design of the warnings

Note and follow the safety instructions and hazard warnings. This is a basic requirement for safe use of the product. The various notes and instructions are identified by corresponding symbols. The design of the warnings, etc. are explained briefly in the following:



**DANGER** The signal word “DANGER!” indicates an impending hazard with high level of risk. If it is not prevented it can cause direct death or severe physical injury.

➔ This arrow indicates the appropriate action to avert the impending hazard.



**WARNING** The signal word “WARNING!” indicates an impending hazard, which can potentially result in severe physical injury or death if it is not prevented.

➔ This arrow indicates the appropriate action to avert the impending hazard.



**CAUTION** The signal word “CAUTION!” indicates an impending hazard, which can result in a slight or moderate physical injury or damage to property if it is not prevented.

➔ This arrow indicates the appropriate action to avert the impending hazard.



**NOTE** The “Note” pictogram gives you tips and recommendations for use and handling of the device.



**SAFETY** Furthermore, other specific pictograms and hazard symbols are used in the relevant places in these operating instructions (as an example here: wear gloves).

## 2 Safety Instructions

---

### 2.1 Intended use

The product is a retooling kit. After retooling certain LANG tools, it is possible to use them to clamp cylindrical or round material instead of rectangular workpieces.

The stamping and clamping devices that can be retooled are described in the "General product description" section.

The retooled clamping device is fixed solely with the fixing systems of LANG Technik GmbH intended for this purpose.

- for workpieces made of steel, cast metal, non-ferrous metal and plastic.
- in order to machine them on enclosed milling machines, machining centres and machine tools of a similar type and on their rotary tables at up to 500 rpm.

Any further use is deemed to be improper use. The manufacturer is not liable for any resulting damage.

### 2.2 Improper use



**CAUTION** In case of improper use, the product, the workpiece and the machine tool can cause significant danger due to uncontrolled machine behaviour. For example, due to tools and workpieces flying off in all directions.

- ➔ The product may only be used within the scope of its technical data. See "Technical data" section. In particular, the clamping forces and speeds must be complied with.
- ➔ Modifications or alterations to the product are not allowed. Only use the approved original spare parts and accessories of LANG Technik GmbH (see Spare parts and accessories section).

### 2.3 Operating personnel requirements

The owner/operating company undertakes:

- To allow only trained, skilled personnel (with metalworking training) or CNC millers, aged 18 or over, to work with the product.
- To clearly define the responsibilities of the personnel with regard to installation, starting up, operation, maintenance and repair.
- To allow personnel to be instructed only to work with the product under the supervision of an experienced skilled person (metal subject) or a CNC operator.

## 2 Safety Instructions

### All persons assigned to operate or use the product undertake:

- To ensure the safety of third persons, the product and the machine tool (machining centre) at all times.
- To read the operating instructions, the safety section and the warnings and, with their signature, confirm that they have understood them.
- To comply with the fundamental regulations regarding occupational safety and accident prevention, depending on the working environment.
- To use the product only if they are familiar with the function of the product itself as well as the function of the machine tool / the machining centre and their safety and emergency devices and can control them safely.
- The operating personnel must pay full attention to the work with the machine tool / the machining centre and the product.
- Work with this product with continuous attention, in a controlled way and sensibly. Do not use the product if you are tired or are under the influence of drugs, alcohol or medication.

### 2.4 Personal protective equipment and safety of persons



- Personal protective equipment must be worn according to the guidelines and regulations of the German "Berufsgenossenschaft" (German institutions for statutory accident insurance and prevention) and the company's regulations (work clothing, as well as slip-resistant safety footwear, gloves, hair net, etc.). Ask your employer's safety representative for information.

### 2.5 Improper handling is ...

- ... if the product is operated without a safeguard.
- ... if it is used for purposes other than intended, for example, as a pressing or punching tool, as a toolholder, as a load carrying device or as lifting gear.
- ... the product is used in unplanned machines or for unplanned workpieces.
- ... if the specified technical data are exceeded during use of the product (see "Technical data" section).
- ... if workpieces are not clamped properly, with the specified clamping forces.
- ... if the product is not used in allowable working environment conditions.

Do not manipulate or change the product.

Check the product before each use to ensure that it functions properly. If the product does not function properly, it must be taken out of operation and clearly marked as defective. Never use the product before it has been properly repaired.

## 2 Safety Instructions

### 2.6 Working environment



**CAUTION** Risk of slipping and falling due to dirty surroundings (e.g. due to metalworking fluids or oil).



- Wear safety footwear with slip-resistant sole.
- Ensure that the working environment is clean.

### 2.7 Transport and storage

#### Transport



**CAUTION** Risk of injury due to the product falling during transport or attachment and dismantling (installation).

- Wear stable safety footwear, e.g. with steel toecap.

#### Storage



**CAUTION** Eye injuries possible.

Risk of injury caused by compressed air in the form of grease, oil and other particles sprayed around.



- Wear goggles.



**ATTENTION** Grease can cause allergic skin reactions.

- Wear protective gloves.

Before placing in storage, remove all liquids, e.g. coolants. Either blow out the clamping device with compressed air or put it down so that the liquids can drain.

- Collect the discharging liquids and dispose of properly according to the legal requirements.
- Store the product in a dry place. Humidity 5–85%.
- Place the product in a safe, stable position and near the floor.

### 2.8 Disposal

All components of the product are made of steel and can be disposed of as waste metal.

## 3 Product Description

### 3.1 General product description

The product is a retooling kit for LANG devices/tools. In case of retooling, both systems **must** be adapted.

- The Makro-4Grip®**stamping jaws** are for the Makro-Grip®**stamping station**
- The Makro-4Grip®**clamping jaws** are for the Makro-Grip®**5-axis clamp**.

By retooling the two LANG tools named above it is possible to stamp and clamp cylindrical workpieces or round materials.

Application	For devices/tools (type)	Retooling kit consisting of	Jaw width
Stamping	Lang stamping station (41200, 41350, 41521, 41400, 41402)	One pair of jaws with 4 stamping inserts and mounting screws	170 mm
Clamping	5-axis clamp Makro-Grip® 77	Pair of clamping jaws	52 mm
			77 mm
	5-axis clamp Makro-Grip® 125	Pair of clamping jaws	90 mm
			128 mm

### 3.2 Scope of supply of the clamping jaws and scope of supply of the stamping jaws

Pair of Makro-4Grip® clamping jaws



Scope of supply:  
2x clamping jaws

Makro-4Grip® stamping jaws

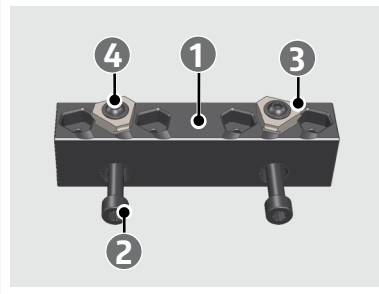

Scope of supply:  
2x stamping jaws (1)  
2x hex socket head cap screw (2) M8x30  
2x stamping jaw insert (3)  
2x raised cheese head screw (4) M6x25



## 4 Installation of the Makro·4Grip Stamping Jaws on the Stamping Station

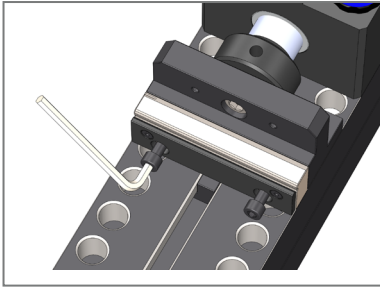

Fig. 1

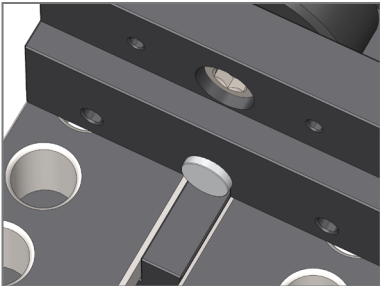

Fig. 2

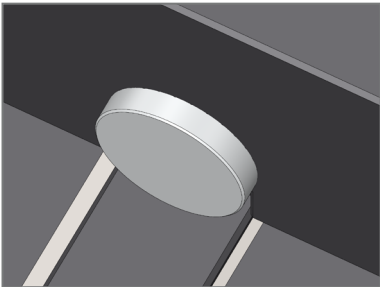

Fig. 3

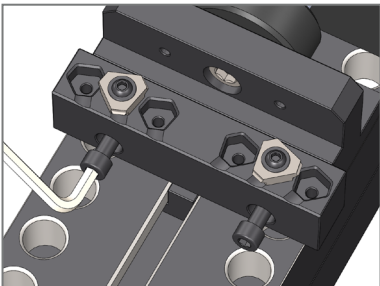

Fig. 4

### 4.1 Dismantling/mounting the base jaws on the stamping station



**CAUTION** Risk of injury  
Risk of crushing due to manually/hydraulically moved clamping devices.



→ Before carrying out the adjustment work, disconnect the stamping station from the compressed air supply.



→ Always familiarise yourself with the function and safety instructions of the stamping station:  
See "Stamping station (41200/41350/41521/41400/41140/41402)" operating instructions



→ Do not grip between the clamping jaws.  
Wear safety gloves.

Tools required:

Allen key A/F 6, torque wrench.

Tightening torque of the hex socket head cap screw (M8): 26 Nm.

For improved access, push the hydraulic housing all the way back and remove the protective screen.

#### Dismantle:

Dismantle the linear stamping jaws (Fig. 1):

1. Undo and remove both hex socket head screws in the linear stamping jaw.
2. Remove the jaws.
3. Keep the jaws with the hex socket head screws.

#### Check:

Is the plug still in the correct position? If it has detached itself from the hole it must be reinserted.

Correct fit of the plug:

The plug fits correctly when it protrudes uniformly by half its depth from the hole (Fig. 2+3).

#### Mounting the round stamping jaws:

Use the screws supplied with the round stamping jaws to mount the jaws. M8 x 30, torque 26 Nm.

1. Mount the Makro-4 Grip jaws. Position and screw on (Fig. 4). Keep an eye on the position of the plug.
2. The procedure is the same for the dismantling/mounting of the second stamping jaw.

## 4 Installation on the Stamping Station

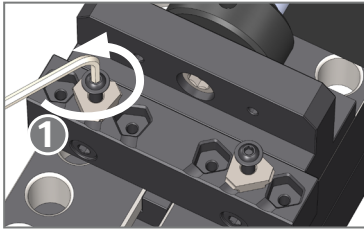

Fig. 5

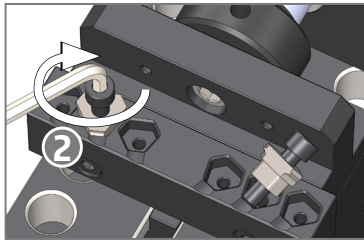
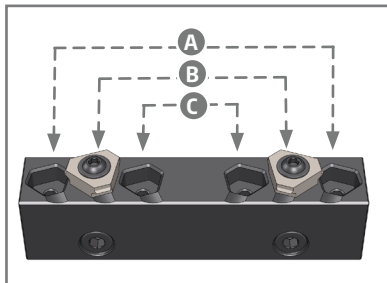

Fig. 6



### 4.2 Dismantling/mounting and moving the stamping inserts

Tools required: Allen key A/F 4, torque wrench, M 8 screw (minimum length 30 mm) or a pin puller for pulling the stamping inserts out of the hole.

Tightening torque of the raised cheese head screw:  
**15 Nm.**

Procedure:

**1. Undoing the stamping inserts** (Fig. 5, Item 1)  
Undo and remove the raised cheese head screw

**2. Pulling off the stamping inserts** (Fig. 6, Item 2)  
Use a puller or an M8 screw (approx. 30 mm) to "pull off" the stamping insert. I.e. screw in the screw until the stamping insert is released. If a suitable screw is not to hand, the mounting screw of the stamping jaw can also be used.

#### 3 a. Turning or replacing stamping inserts

If an edge of the stamping insert is worn, two others can be used by remounting the stamping inserts turned by 120 degrees. If all the edges are worn they must be replaced by new stamping inserts.



#### CAUTION

Damage to property or physical injury is possible.

Incorrectly mounted components can cause workpieces to loosen during subsequent stamping or clamping (e.g. due to asymmetrical arrangement of the stamping inserts).

→ All mounting operations must be carried out identically on both stamping jaws and the stamping inserts.

#### 3 b. Moving the stamping inserts

The stamping inserts can be moved to adjust the stamping inserts to different workpiece diameters/clamping jaws. This must always be done pair-wise. I.e. both inserts in Position A, Position B or C and on both stamping jaws are identical. See also the "Positioning the stamping inserts" section.



#### CAUTION Physical injury is possible

→ If the protective screen was removed for the mounting work, it must then be remounted!

## 5 Installation on the Central Clamp



Fig. 7

### 5.1 Changing the clamping jaws

The clamping jaws you need depends on the workpiece and the clamping body. See Selecting suitable clamping jaws section.

#### Tools required:

Allen key A/F 5.

The cordless screwdriver attachment Art. No. 47005 (Fig. 7) is very useful, as it presses the jaws against the spindle during the turning movement.



**CAUTION** Risk of crushing  
When changing the clamping jaws there is a risk of crushing on opening and closing the clamping jaws.



- Do not grip between the clamping jaws.
- Wear protective gloves.

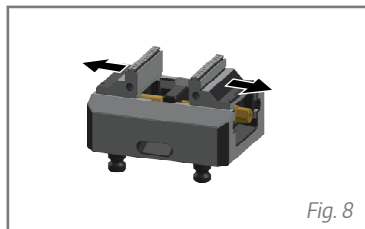

Fig. 8

### 5.2 Dismantling Makro-Grip clamping jaws

Figure 8:

Turn the threaded spindle anticlockwise until the clamping jaws are clear (Allen key A/F 5 or cordless screwdriver attachment Art. No. 47005).

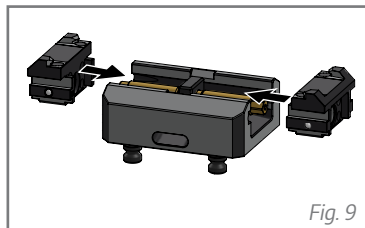

Fig. 9

### 5.3 Mounting Makro-4Grip clamping jaws

Figure 9:

Push the two 4-Grip clamping jaws into the guides until they noticeably lie against the thread of the spindle.

Turn the spindle clockwise and ensure that both jaws are engaged by the thread simultaneously ("threading in").

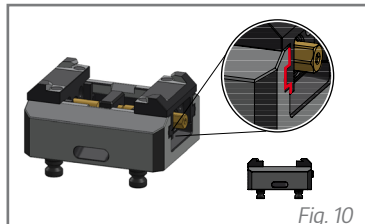

Fig. 10

Figure 10 (magnified detail):

Body edges check point. If the clamping jaws plunge into the base body in a straight position, you can check whether they move centrally towards each other. If not, the "threading in" must be repeated.

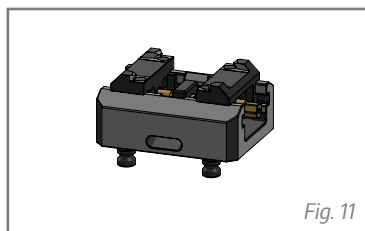

Fig. 11

Figure 11:

If the clamping jaws move centrally, the 4Grip clamp is ready for use.

## 6 Notes and Data for Setting Up

### 6.1 Selecting the suitable clamping jaws according to the workpiece diameter

The choice of clamping jaws depends on the workpiece diameter (A) and the clamp type (B). The combination of A and B gives the suitable clamping jaws (C).

- **A:** What is the diameter of the workpiece to be clamped?
- **B:** Which 5-axis clamp do I have or need? Note: The type designation is attached to the base body.
- **C:** This pair of clamping jaws matches it!

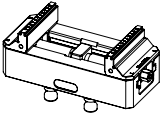
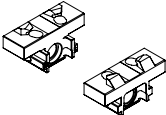
A	+	B	=	C
Required clamping range (workpiece diameter)		5-axis clamp (Art. No.)		Suitable clamping jaws (Type designation, Art. No.)
∅ 36 – 60 mm		48085-46/-77		Makro·4Grip 77 = jaw width 52 mm <b>57708-20</b>
∅ 36 – 85 mm		48120-46 / -77		
∅ 36 – 115 mm		48160-77		
∅ 36 – 115 mm		48200-77		
∅ 43 – 60 mm		47085*		
∅ 43 – 85 mm		47120*		
∅ 43 – 115 mm		47160*		
∅ 43 – 115 mm		47200*		
		* older versions		
				

A	+	B	=	C
Required clamping range (workpiece diameter)		5-axis clamp (Art. No.)		Suitable clamping jaws (Type designation, Art. No.)
∅ 54 – 80 mm		48085-46/-77		Makro·4Grip 77 Jaw width 52 mm <b>57711-20</b>
∅ 54 – 115 mm		48120-46 / -77		
∅ 54 – 115 mm		48160-77		
∅ 54 – 115 mm		48200-77		
∅ 65 – 80 mm		47085*		
∅ 65 – 115 mm		47120*		
∅ 65 – 115 mm		47160*		
∅ 65 – 115 mm		47200*		
		* older versions		

## 6 Notes and Data for Setting Up

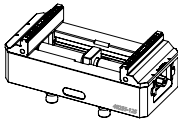
A	+	B	=	C
<b>Required clamping range</b> (workpiece diameter)		<b>5-axis clamp</b> (Art. No.)		<b>Suitable clamping jaws</b> (Type designation, Art. No.)
∅ 115 – 130 mm		48155-77 / -125		Makro-4Grip 125 Jaw width 90 mm <b>52515-20</b>
∅ 115 – 180 mm		48205-77 / -125		
∅ 115 – 180 mm		48255-125		
∅ 115 – 180 mm		48305-125		
∅ 115 – 180 mm		48355-125-125		
∅ 115 – 130 mm		47155*		
∅ 115 – 180 mm		47205*		
∅ 115 – 180 mm		471255*		
∅ 115 – 180 mm		47305*		
∅ 115 – 180 mm		47355*		
		* older versions		
				

A	+	B	=	C
<b>Required clamping range</b> (workpiece diameter)		<b>5-axis clamp</b> (Art. No.)		<b>Suitable clamping jaws</b> (Type designation, Art. No.)
–		48155-77/-125		Makro-4Grip 77 Jaw width 52 mm <b>52530-20</b>
∅ 180 – 200 mm		48255-77 / -125		
∅ 180 – 245 mm		48255-125		
∅ 180 – 290 mm		48305-125		
∅ 180 – 300 mm		48355-125-125		
–		47155*		
∅ 180 – 200 mm		47205*		
∅ 180 – 245 mm		47255*		
∅ 180 – 290 mm		47305*		
∅ 180 – 300 mm		47355*		
		* older versions		

Constellation example:

Workpiece diameter	5-axis clamp (Art. No.)	<b>Suitable clamping jaws</b> (Type designation, Art. No.)
<b>∅ 80 mm</b>	<b>48200-77</b>	<b>Makro-4Grip 77</b> Jaw width 52 mm <b>57708-20</b>

## 6 Notes and Data for Setting Up

### 6.2 Positioning of the stamping inserts based on the clamping jaw type

The following diagram shows the positions in which the stamping inserts must be inserted and screwed.

The stamping inserts must be positioned in the stamping jaws at different spacings. This depends on the types of clamping jaws used.

**Tip:** Read also section: "Selecting the suitable clamping jaws according to workpiece diameter".

#### Clamping jaw types

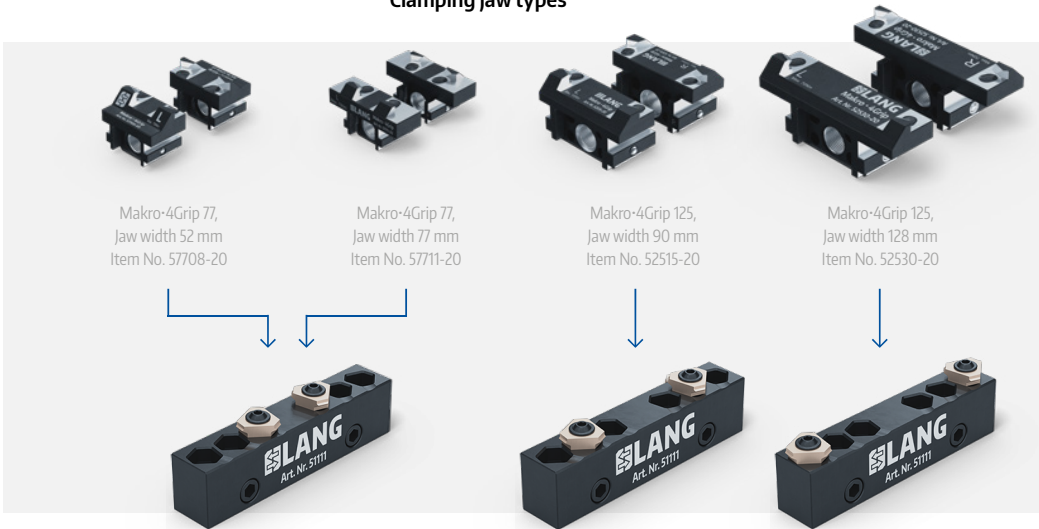

#### Positioning of the stamping inserts

### 6.3 Tightening torques of the mounting screws in the stamping jaws

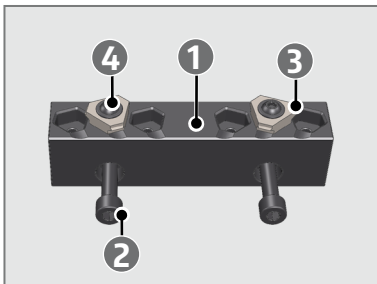

1	Pair of stamping jaws Art. No. 51111	
2	Hex socket head screws M8x30	26 Nm
3	Stamping jaw insert Art. No. 51111	
4	Raised cheese head screws M6x25	15 Nm

## 7 Stamping and Clamping



### CAUTION Risk of injury!

Risk of crushing due to hydraulically and pneumatically driven clamping devices.



- Always familiarise yourself with the function of the stamping station. See stamping station (41200/41350/41521/41400/41140/41402) operating instructions.
- Do not grip between the jaws. Wear protective gloves.



**WARNING Risk of injury!** If the workholding is defective, parts of the tool or workpiece can be ejected / fly out into the surroundings and cause severe injuries.



- Wear goggles and stay behind the protective screen during the stamping operation.
- When using the Makro-4Grip stamping jaws, do not exceed the **maximum clamping pressure** of **50 bar** at the stamping station. Can be read off at the hydraulic pressure gauge. See "Stamping station (41200/41350/41521/41400/41140/41402)" operating instructions.
- Make sure that the clamping devices and stamping tools match the workpiece dimensions. See "Notes and data for setting up" section

### 7.1 Illustration of a model stamping



Fig. 12

Unlike stamping of cubic blanks, the Makro-4Grip stamping technique does not require a depth stop to check the correct stamping depth. Therefore, a visual check is mainly used to determine whether the input pressure of the stamping unit has been chosen correctly. The ideal impression for round stamping is uniformly flat. The values of the possible workpiece diameter for each jaw size given in the tables on page 12-13 ensure such an impression. The stamping pressure required depends on the material. The penetration depth required is also based on the workpiece diameter.

We recommend starting with a low stamping pressure and increasing it slowly until the required stamped depth is reached in the workpiece. However, only up to a hydraulic pressure of **maximum 50 bar**.

## 7.2 Example combination of stamping and clamping devices

An example of an optimum constellation of workpiece diameter, clamp and stamping jaw position.

- The data in the table are taken from the section: "Selecting the suitable clamping jaws according to the workpiece diameter".

Workpiece diameter	5-axis clamp (Art. No.)	Suitable clamping jaws (Type designation, Art. No.)	Position of the stamping inserts
ø 80 mm	48200-77	Makro·4Grip 77 Jaw width 52 mm 57708-20	Inside

- Material: Case-hardened steel [16MnCr5]
- Position of the stamping inserts: Inside (taken from the "Positioning of the stamping inserts based on the clamping jaw type" section)
- Stamping pressure: max. 50 bar at the stamping station
- Tightening torque at the clamp: 70 Nm

## 7.3 Exemplary example settings at the stamping station

Exemplary examples for stamping pressure settings in bar depending on the workpiece diameter and material properties:

Do not rely on the reference values given! Before each stamping series, perform a test stamping and check the stamped contour visually. Figure 12 shows an ideal stamped pattern.

Material	Rm (in N/mm <sup>2</sup> )	Workpiece diameter (mm)					
		ø 40 mm	ø 60 mm	ø 80 mm	ø 100 mm	ø 120 mm	ø 130 mm
Aluminium (7075)	~550	~10 bar*	~20 bar*	~40 bar*	~10-15 bar*	~15 bar*	~40 bar*
Case-hardened steel (16MnCr5)	~750	~15 bar*	~25 bar*	~50 bar*	~10-15 bar*	~30 bar*	~40-50 bar*
* Display at the hydraulic pressure gauge of the stamping station		Clamping jaw Art. No. 57708-20			Clamping jaw Art. No. 52515-20		

## 7.4 Tightening torque at the clamping screw of the central clamp

When clamping on the threaded spindle with the torque wrench

**Max. 70 Nm**

**Note:** The maximum tightening torque on the spindle indicates what the clamp can achieve. It does not have to be fully utilised. An experienced cutting machine operator can approach the necessary clamping force by trying.

Various factors influence the stability of the clamping, such as:

Material properties (hard, soft tough, brittle), workpiece diameter, clamped size, feed, etc. In case of very soft materials (e.g. plastics) it is even easier to clamp directly instead of prestamping. Here, also, an experienced cutting machine operator can approach the suitable values by test stamping beforehand.



## 8 Spare parts

### 8.1 Stamping



Makro·4Grip stamping jaws

Art. No.	Quantity
51111	1 pair

Including: 4 stamping jaw inserts. Suitable for all versions of Makro·Grip® stamping stations to date.

Makro·4Grip stamping jaw inserts

Art. No.	Quantity
51111-40	4

Each stamping jaw insert has three cutting edges. If a cutting edge is worn, the stamping jaw insert can be turned two more times. For a uniform stamping and clamping quality, always make sure that all four stamping inserts are turned / replaced at the same time.

### 8.2 Clamping



Makro·4Grip clamping jaws  
Jaw width 52

Art. No.	Quantity
57708-20	1 pair

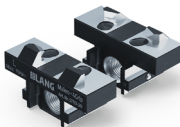

Makro·4Grip clamping jaws  
Jaw width 77

Art. No.	Quantity
57711-20	1 pair

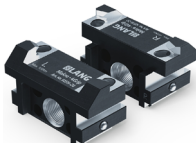

Makro·4Grip clamping jaws  
Jaw width 90

Art. No.	Quantity
52515-20	1 pair

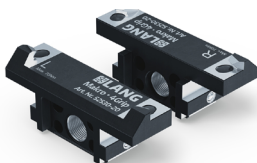

Makro·4Grip clamping jaws  
Jaw width 128

Art. No.	Quantity
52530-20	1 pair

## 9 Dimensions

Makro·4Grip 77 clamping jaws  
Jaw width 52 mm, Art. No. 57708-20

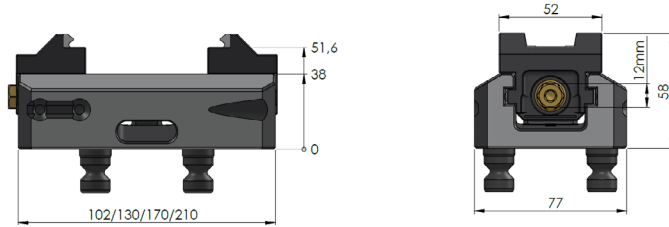

Makro·4Grip 77 clamping jaws  
Jaw width 77 mm, Art. No. 57711-20

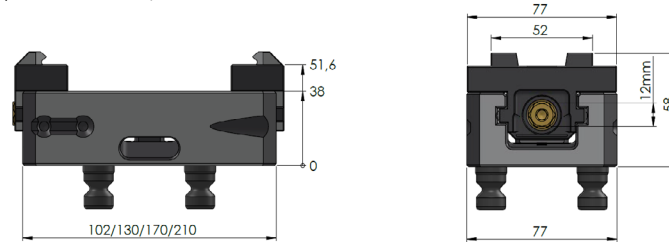

Makro·4Grip 125 clamping jaws  
Jaw width 90 mm, Art. No. 52515-20

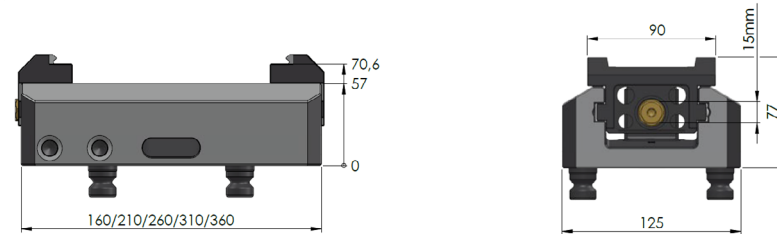

Makro·4Grip 125 clamping jaws  
Jaw width 128 mm, Art. No. 52530-20

