

Vario-Tec 77, Étau de centrage

Largeur des mors 77 mm, plage de serrage max. 137 mm

Item No. 42137-77



Plage de Serrage	0 - 137 mm
Dimensions	210 x 77 x 65 mm
Principe de Serrage	par adhérence
Type de Composant	cubique
Conditionnement	1 Pièce
Poids	4.6 kg
Matériau	Acier

Vario-Tec 77, Étau de centrage

Largeur des mors 77 mm, plage de serrage max. 137 mm

Item No. 42137-77

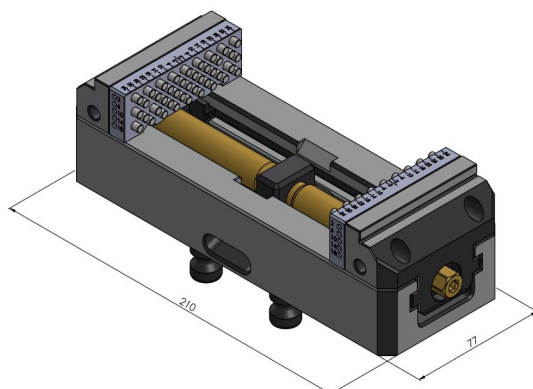
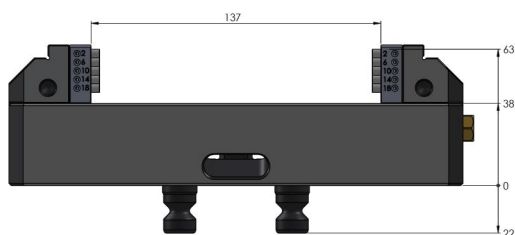

Vario-Tec 77, Étau de centrage

Largeur des mors 77 mm, plage de serrage max. 137 mm

Item No. 42137-77

