

## Profilo 125, Konturspanner

Backenbreite 160 mm, max. Spannbereich 255 mm

Item No. 49150-125



<b>Spannbereich</b>	0 - 255 mm
<b>Abmessungen</b>	260 x 125 x 77 mm
<b>Spannprinzip</b>	kraftschlüssig
<b>Bauteilform</b>	kubisch / zylindrisch / asymmetrisch
<b>Verpackungseinheit</b>	1 Stück
<b>Gewicht</b>	13.4 kg
<b>Material</b>	Stahl

## Profilo 125, Konturspanner

Backenbreite 160 mm, max. Spannereich 255 mm

Item No. 49150-125

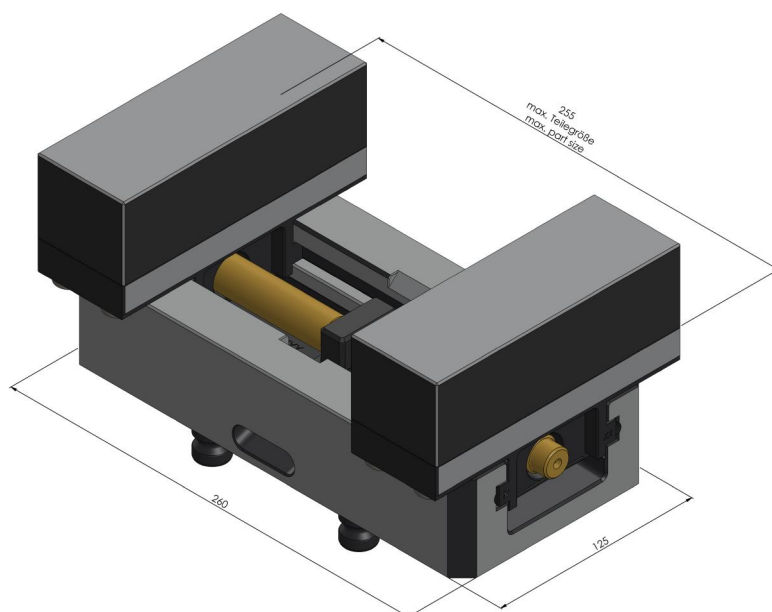
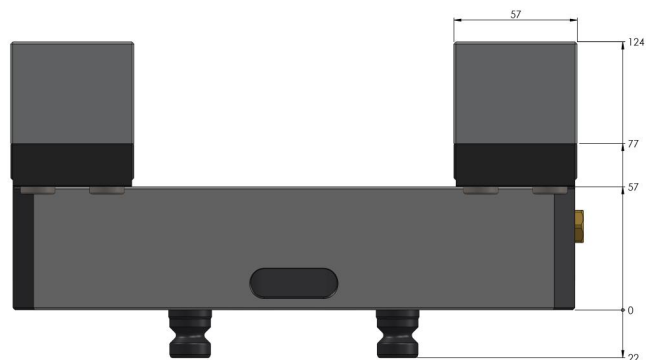

## Profilo 125, Konturspanner

Backenbreite 160 mm, max. Spannereich 255 mm

Item No. 49150-125

