

Profilo 125, Konturspanner

Backenbreite 160 mm, max. Spannbereich 155 mm

Item No. 49050-125



Spannbereich	0 - 155 mm
Abmessungen	160 x 125 x 77 mm
Spannprinzip	kraftschlüssig
Bauteilform	kubisch / zylindrisch / asymmetrisch
Verpackungseinheit	1 Stück
Gewicht	9.7 kg
Material	Stahl

Profilo 125, Konturspanner

Backenbreite 160 mm, max. Spannereich 155 mm

Item No. 49050-125

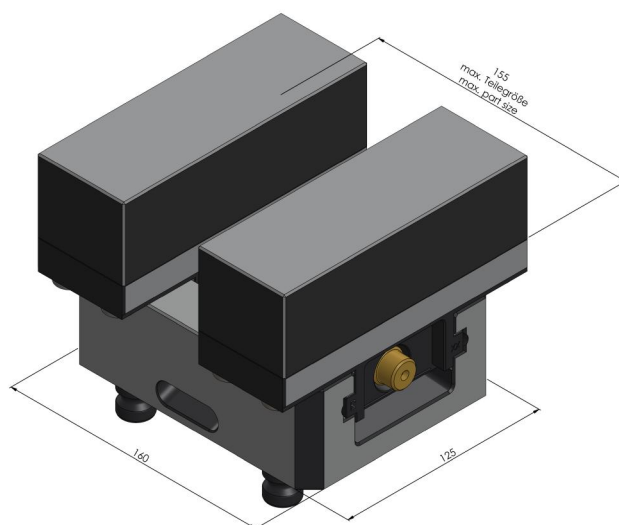
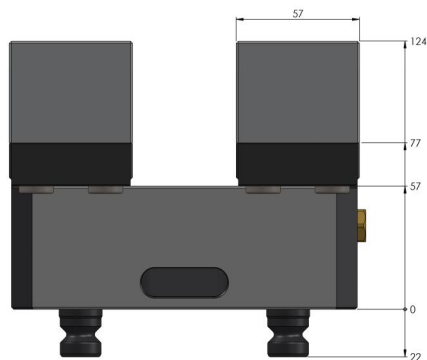

Profilo 125, Konturspanner

Backenbreite 160 mm, max. Spannereich 155 mm

Item No. 49050-125

