

ITEM NO.	49200-TG125
DESCRIPTION	Profilo 125, Center Jaw + Spindle, Jaw width 160 mm, Spindle length 314 mm
ISSUE DATE	04.05.2021 Page 1 / 2

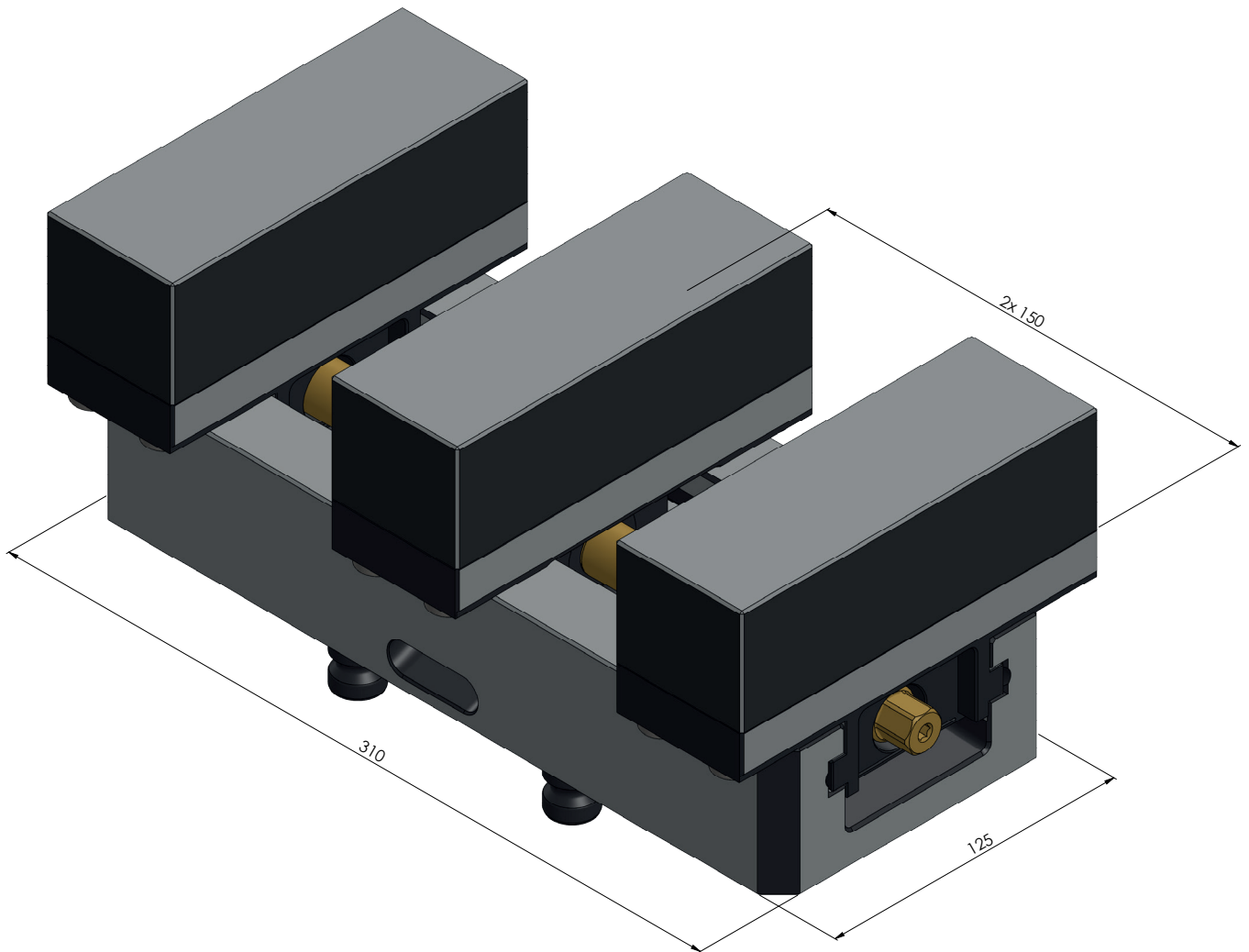

ITEM NO.	49200-TG125
DESCRIPTION	Profilo 125, Center Jaw + Spindle, Jaw width 160 mm, Spindle length 314 mm
ISSUE DATE	04.05.2021

Page 2 / 2