

Avanti 125, Profile Clamping Vice

jaw width 125 mm, max. clamping range 355 mm

Item No. 44355-125

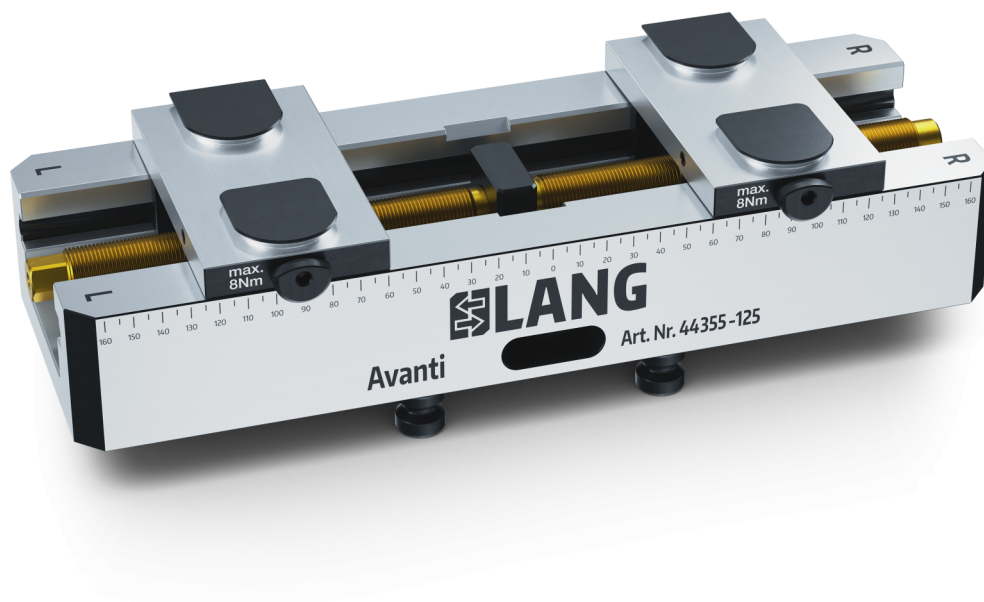

Clamping range	0 - 360 mm (0" - 14.17")
Dimensions	360 x 125 x 70 mm (14.17" x 4.92" x 2.76")
Clamping method	by friction
Workpiece shape	prismatic / cylindrical / asymmetrical
Packaging Unit	1 Set
Weight	16.7 kg (36.82 lbs)
Material	Steel

Avanti 125, Profile Clamping Vice

jaw width 125 mm, max. clamping range 355 mm

Item No. 44355-125

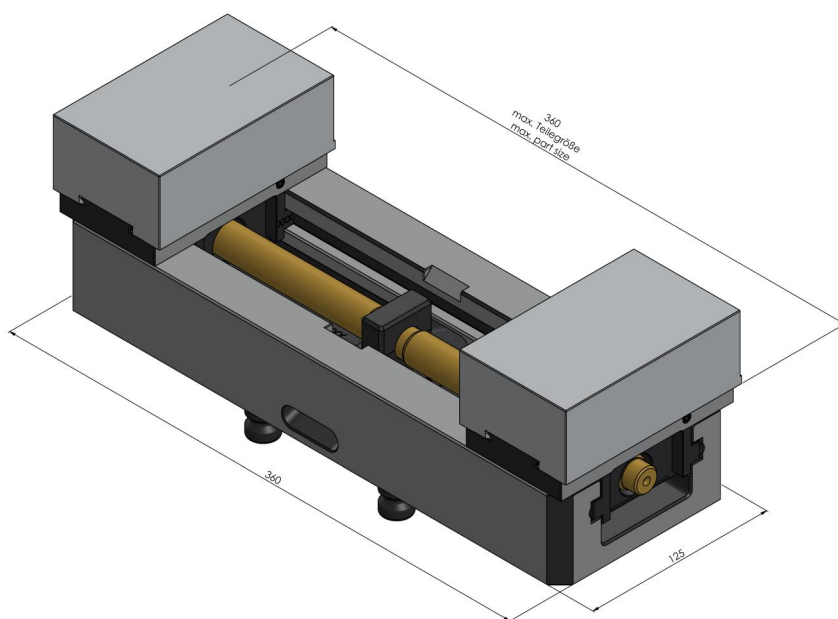
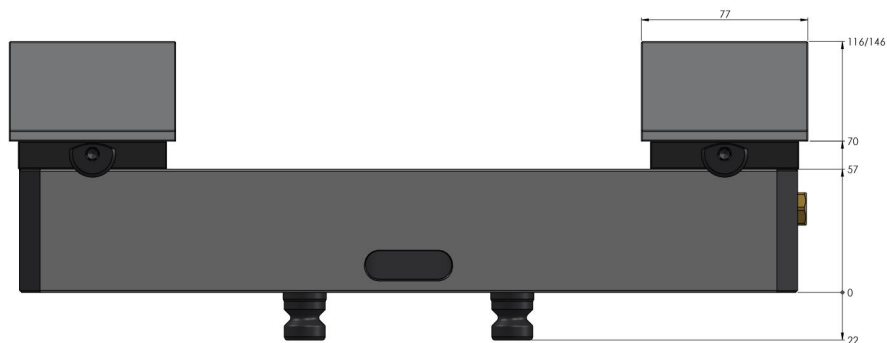

Avanti 125, Profile Clamping Vice

jaw width 125 mm, max. clamping range 355 mm

Item No. 44355-125

