

Avanti 125, Konturspanner

Backenbreite 125 mm, max. Spannbereich 360 mm

Item No. 44355-125

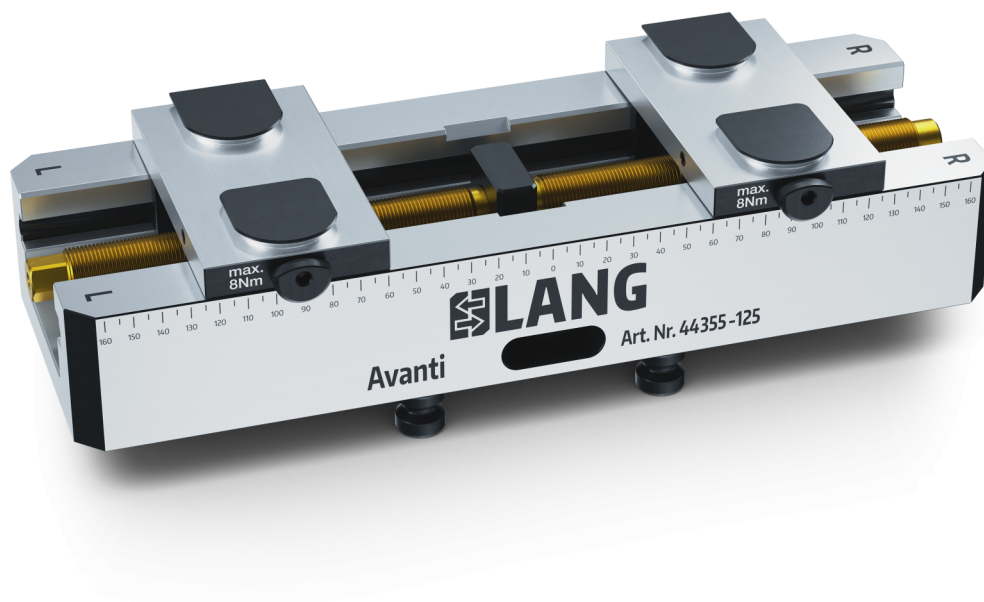

Spannbereich	0 - 360 mm
Abmessungen	360 x 125 x 70 mm
Spannprinzip	kraftschlüssig
Bauteilform	kubisch / zylindrisch / asymmetrisch
Verpackungseinheit	1 Set
Gewicht	16.7 kg
Material	Stahl

Avanti 125, Konturspanner

Backenbreite 125 mm, max. Spannereich 360 mm

Item No. 44355-125

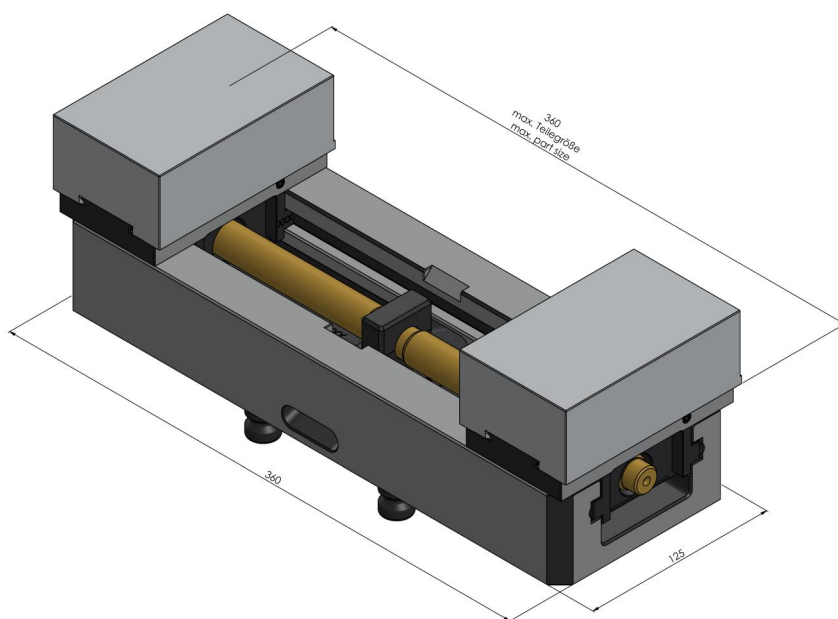
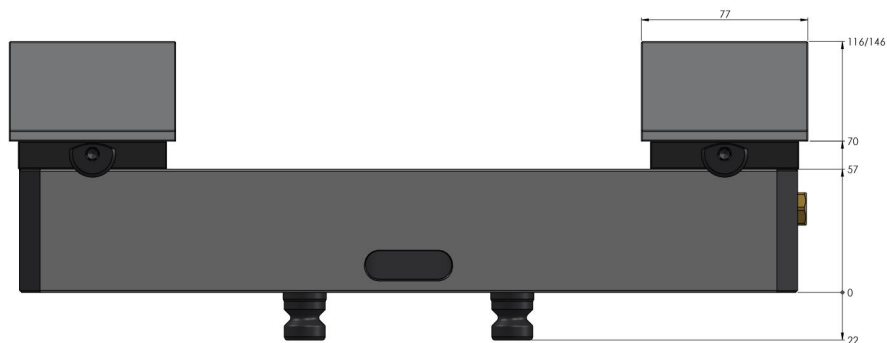

Avanti 125, Konturspanner

Backenbreite 125 mm, max. Spannereich 360 mm

Item No. 44355-125

