

Avanti 125, Profile Clamping Vice

jaw width 125 mm, max. clamping range 305 mm

Item No. 44305-125

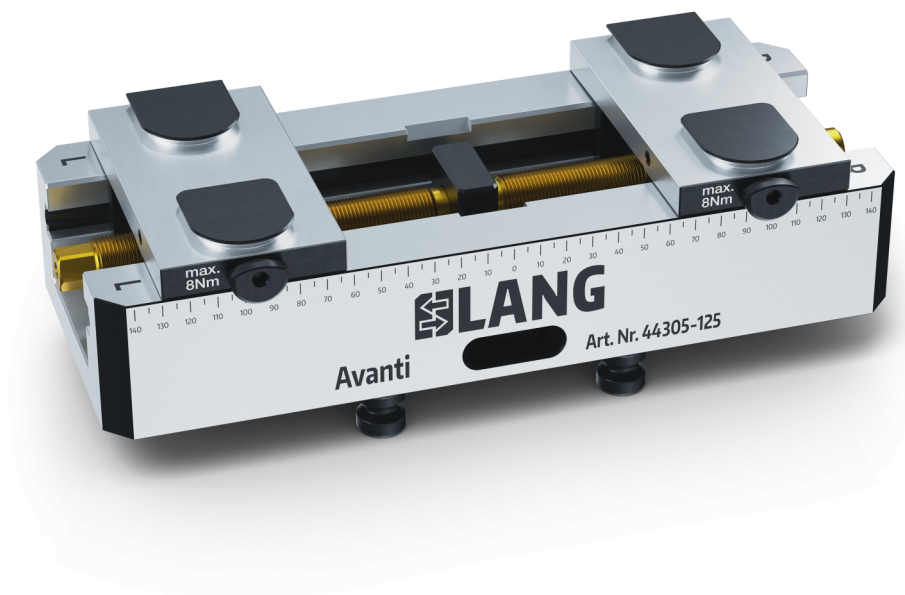

Clamping range	0 - 310 mm (0" - 12.2")
Dimensions	310 x 125 x 70 mm (12.2" x 4.92" x 2.76")
Clamping method	by friction
Workpiece shape	prismatic / cylindrical / asymmetrical
Packaging Unit	1 Set
Weight	14.9 kg (32.85 lbs)
Material	Steel

Avanti 125, Profile Clamping Vice

jaw width 125 mm, max. clamping range 305 mm

Item No. 44305-125

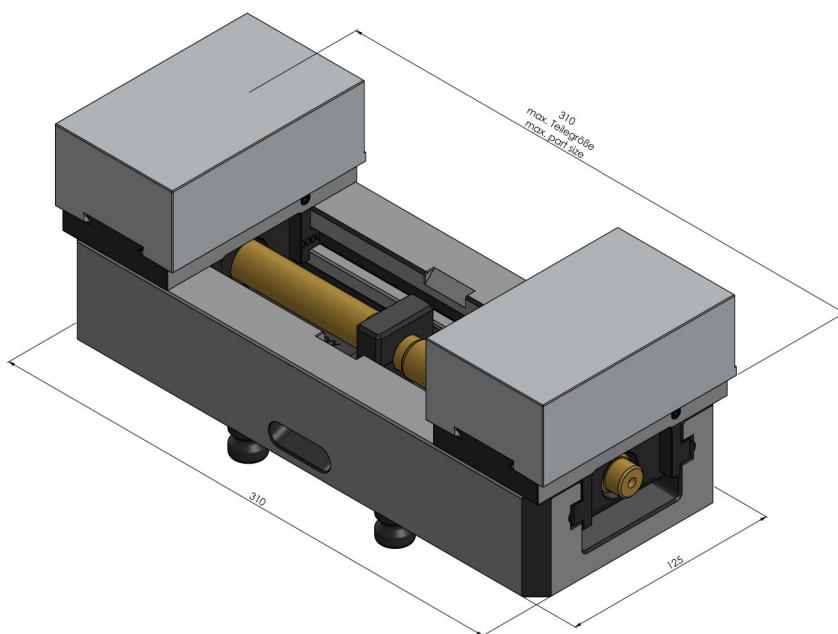
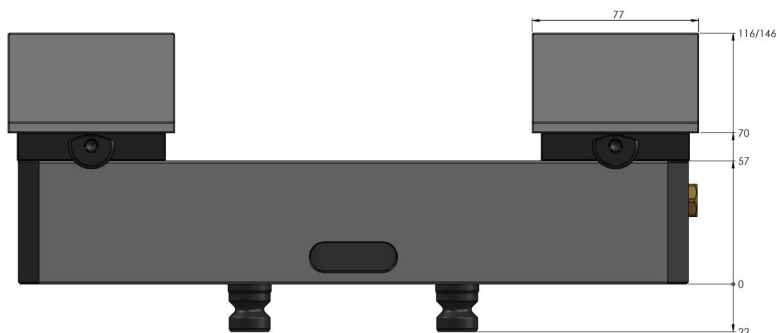

Avanti 125, Profile Clamping Vice

jaw width 125 mm, max. clamping range 305 mm

Item No. 44305-125

