

Makro-Grip® 77, Center Jaw + Spindle

jaw width 46 mm, jaw thickness 17 mm, spindle length
135 mm

Item No. 48120-TG4617

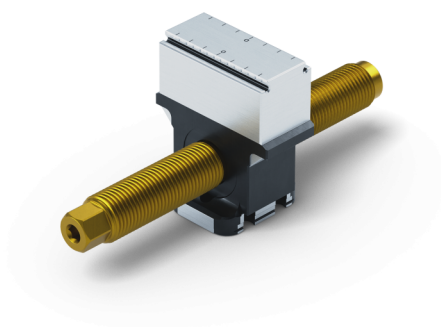

Spindle length	135 mm (5.31")
Clamping range	2 x 50 mm (1.97")
Thread pitch	M16 x 1.5
Dimensions	Jaw width: 46 mm (1.81")
Workpiece shape	prismatic
Packaging Unit	1 Piece
Weight	0.53 kg (1.17 lbs)
Material	Steel

Makro-Grip® 77, Center Jaw + Spindle

jaw width 46 mm, jaw thickness 17 mm, spindle length
135 mm

Item No. 48120-TG4617

