

Makro-Grip® 125, Spindle + Center Piece

spindle length 314 mm

Item No. 4825314

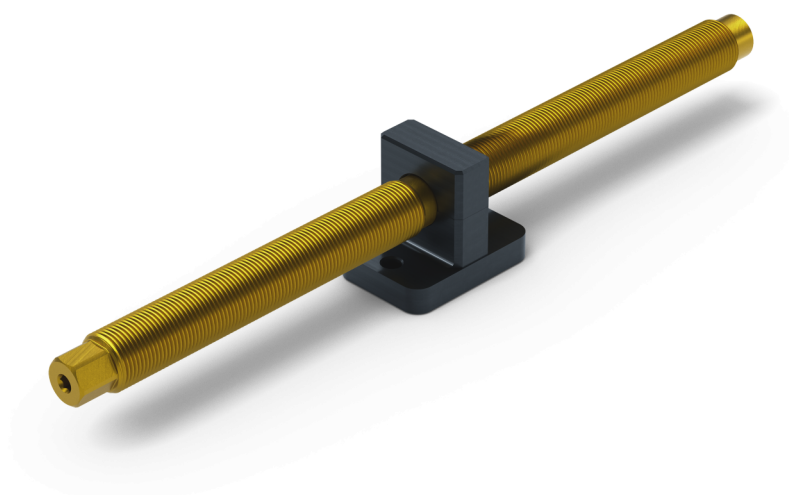

Spindle length	314 mm (12.36")
Thread pitch	M20 x 1.5
Workpiece shape	prismatic / cylindrical / asymmetrical
Packaging Unit	1 Piece
Weight	0.85 kg (1.87 lbs)
Material	Steel

Makro-Grip® 125, Spindle + Center Piece
spindle length 314 mm

Item No. 4825314

