

Makro-Grip® 125, Spindle + Center Piece
spindle length 164 mm

Item No. 4825164

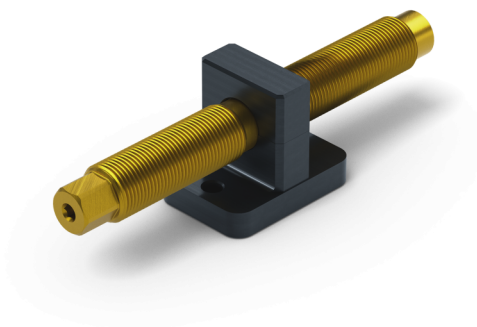

Spindle length	164 mm (6.46")
Thread pitch	M20 x 1.5
Workpiece shape	prismatic / cylindrical / asymmetrical
Packaging Unit	1 Piece
Weight	0.58 kg (1.28 lbs)
Material	Steel

Makro-Grip® 125, Spindle + Center Piece
spindle length 164 mm

Item No. 4825164

