

Avanti 77, Profile Clamping Vice

jaw width 77 mm, max. clamping range 205 mm

Item No. 44200-77



Clamping range	0 - 205 mm (0" - 8.07")
Dimensions	210 x 77 x 51 mm (8.27" x 3.03" x 2.01")
Clamping method	by friction
Workpiece shape	prismatic / cylindrical / asymmetrical
Packaging Unit	1 Set
Weight	4.8 kg (10.58 lbs)
Material	Steel

Avanti 77, Profile Clamping Vice

jaw width 77 mm, max. clamping range 205 mm

Item No. 44200-77

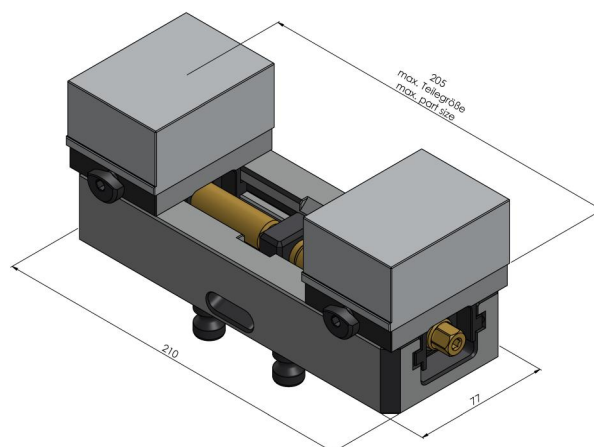
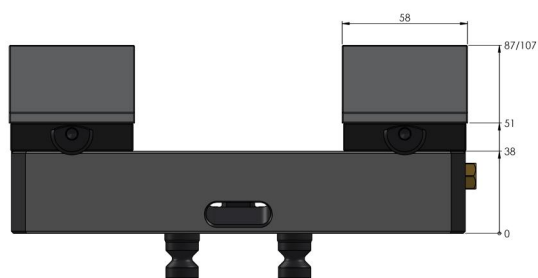

Avanti 77, Profile Clamping Vice

jaw width 77 mm, max. clamping range 205 mm

Item No. 44200-77

