

Avanti 77, Profile Clamping Vice

jaw width 46 mm, max. clamping range 125 mm

Item No. 44120-46



Clamping range	0 - 125 mm (0" - 4.92")
Dimensions	130 x 77 x 48 mm (5.12" x 3.03" x 1.89")
Clamping method	by friction
Workpiece shape	prismatic / cylindrical / asymmetrical
Packaging Unit	1 Set
Weight	2.59 kg (5.71 lbs)
Material	Steel

Avanti 77, Profile Clamping Vice

jaw width 46 mm, max. clamping range 125 mm

Item No. 44120-46

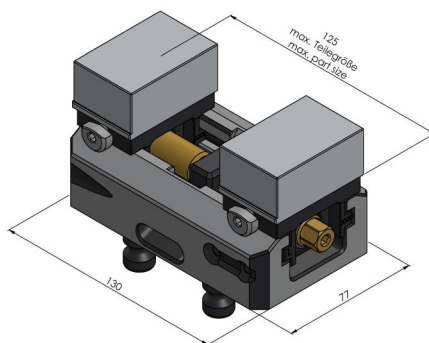
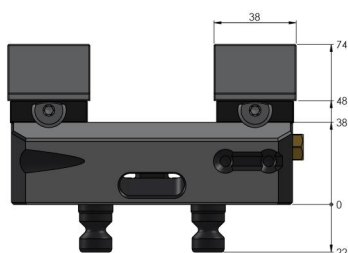

Avanti 77, Profile Clamping Vice

jaw width 46 mm, max. clamping range 125 mm

Item No. 44120-46

