

N° D'ART.	48305-125
DESCRIPTION	Makro-Grip® 125, Étau 5 axes, largeur des mors 125 mm, Plage de serrage 0 - 305 mm
DATE DE PUBLICATION	04.05.2021

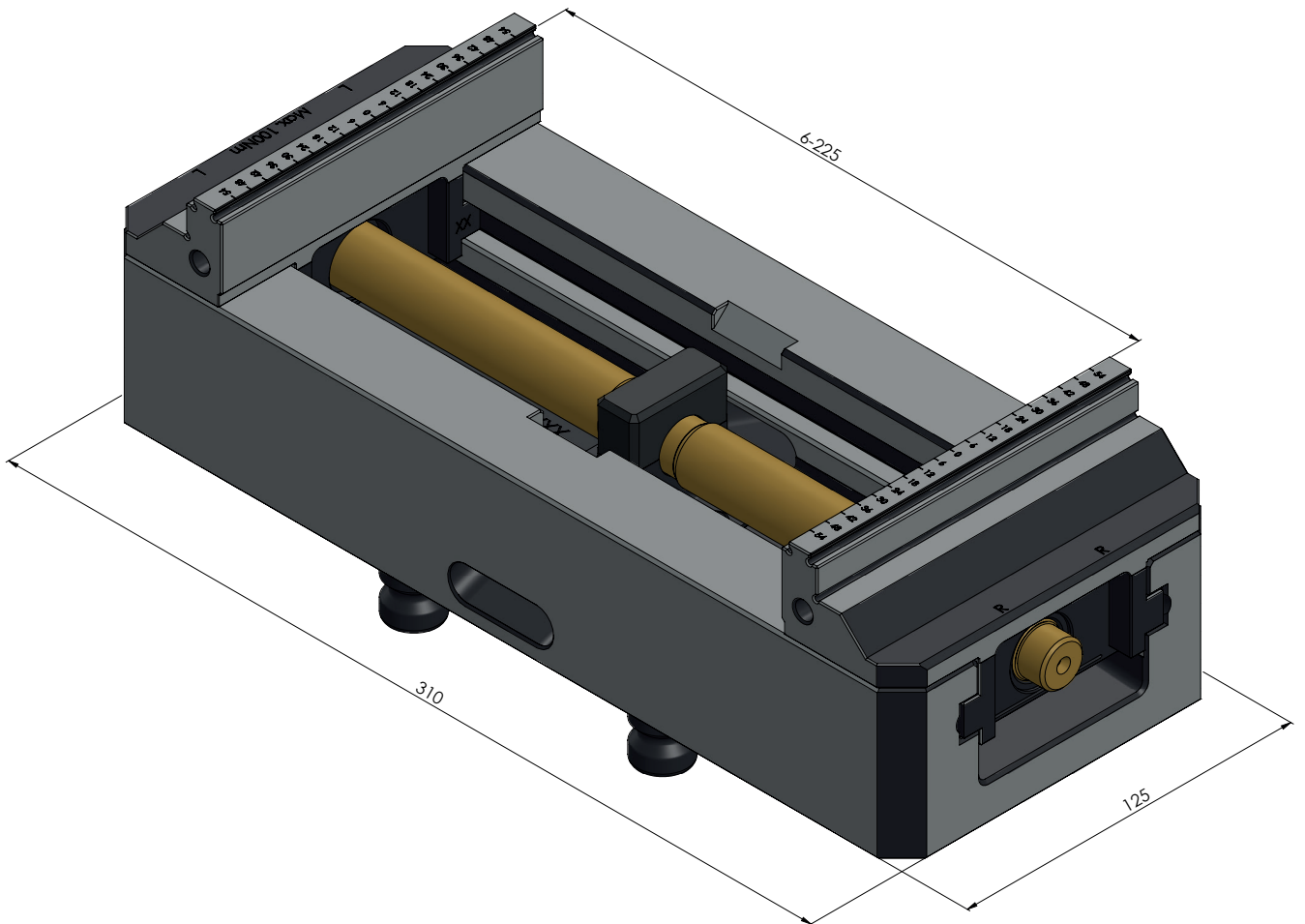

N° D'ART.	48305-125
DESCRIPTION	Makro-Grip® 125, Étau 5 axes, largeur des mors 125 mm, Plage de serrage 0 - 305 mm
DATE DE PUBLICATION	04.05.2021

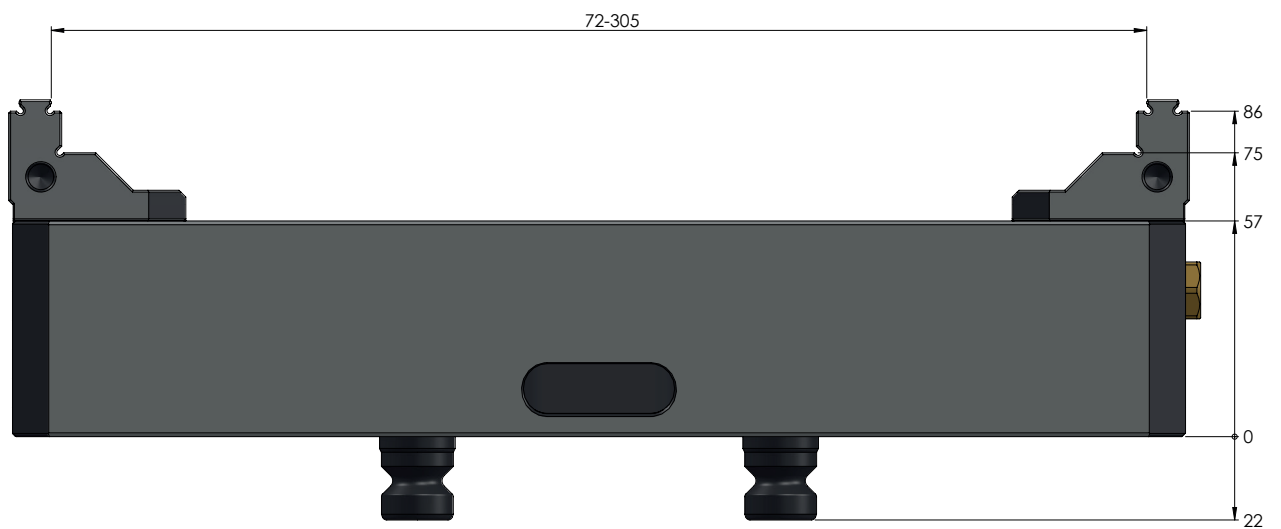

N° D'ART.	48305-125
DESCRIPTION	Makro-Grip® 125, Étau 5 axes, largeur des mors 125 mm, Plage de serrage 0 - 305 mm
DATE DE PUBLICATION	04.05.2021

