

Makro-Grip® 125, 5-Axis Vise

jaw width 77 mm, clamping range 0 - 205 mm

Item No. 48205-77



Clamping range	0 - 205 mm (0" - 8.07")
Dimensions	210 x 125 x 89 mm (8.27" x 4.92" x 3.5")
Clamping method	by form-fit / by friction
Workpiece shape	prismatic
Packaging Unit	1 Piece
Weight	9.1 kg (20.06 lbs)
Material	Steel

Makro-Grip® 125, 5-Axis Vise

jaw width 77 mm, clamping range 0 - 205 mm

Item No. 48205-77

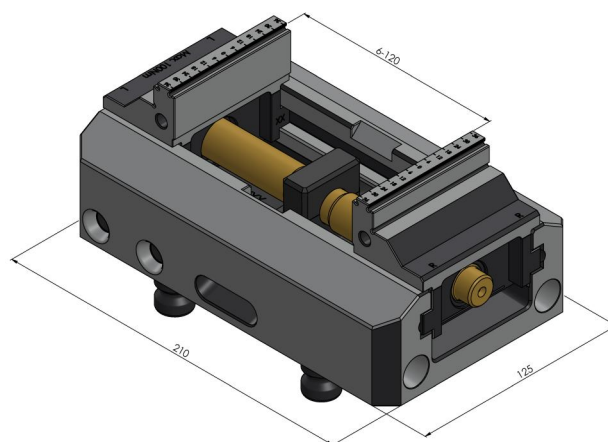
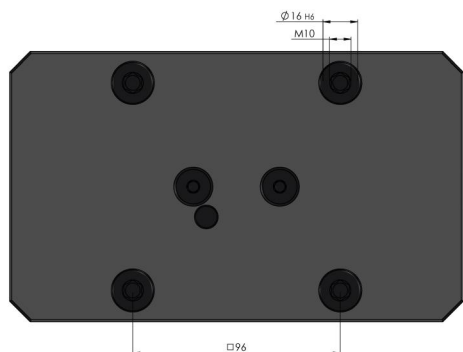

Makro-Grip® 125, 5-Axis Vise

jaw width 77 mm, clamping range 0 - 205 mm

Item No. 48205-77

