

Makro-Grip® 125, morsa a 5 assi

larghezza delle ganasce 77 mm, campo di serraggio 0 - 155 mm

Item No. 48155-77



Campo di serraggio	0 - 155 mm
Dimensioni	160 x 125 x 89 mm
Metodo di serraggio	incastro / bloccato per attrito
Forma del pezzo	cubico
Unità di imballaggio	1 Pezzo
Peso	7.4 kg
Materiale	Acciaio

Makro-Grip® 125, morsa a 5 assi

larghezza delle ganasce 77 mm, campo di serraggio 0 - 155 mm

Item No. 48155-77

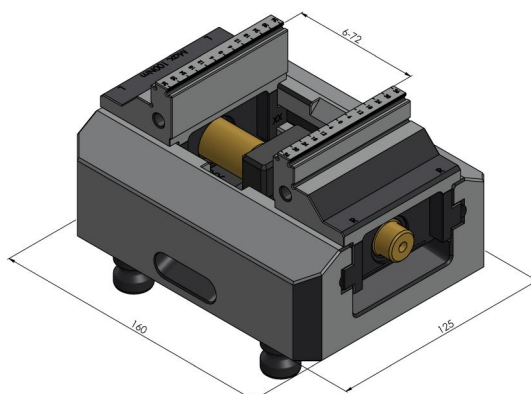
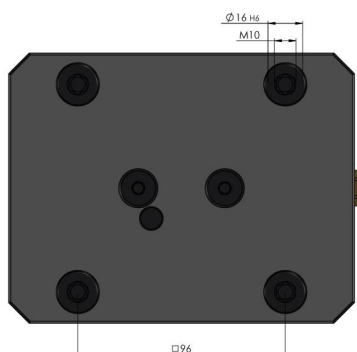

Makro-Grip® 125, morsa a 5 assi

larghezza delle ganasce 77 mm, campo di serraggio 0 - 155 mm

Item No. 48155-77

