

Makro-Grip® 125, Étau 5 axes

Largeur des mors 77 mm, Plage de serrage 0 - 155 mm

Item No. 48155-77

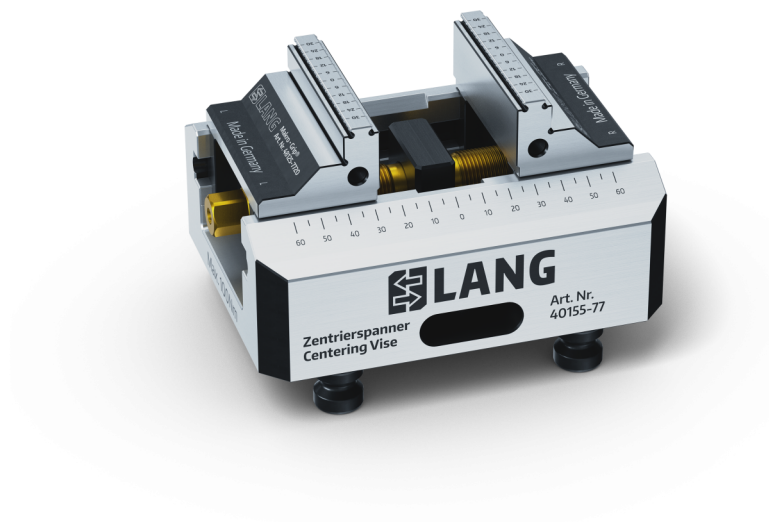

Plage de Serrage	0 - 155 mm
Dimensions	160 x 125 x 89 mm
Principe de Serrage	à engagement positif / par adhérence
Type de Composant	cubique
Conditionnement	1 Pièce
Poids	7.4 kg
Matériau	Acier

Makro-Grip® 125, Étau 5 axes

Largeur des mors 77 mm, Plage de serrage 0 - 155 mm

Item No. 48155-77

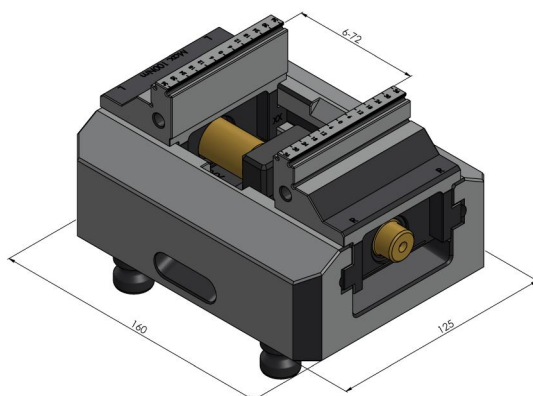
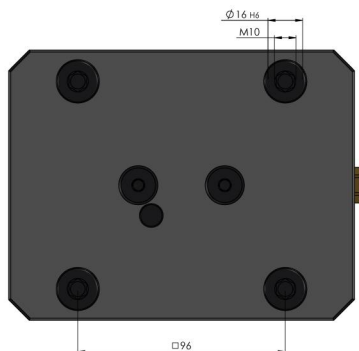

Makro-Grip® 125, Étau 5 axes

Largeur des mors 77 mm, Plage de serrage 0 - 155 mm

Item No. 48155-77

