

Makro-Grip® 77, 5-Axis Vise

jaw width 77 mm, clamping range 0 - 160 mm

Item No. 48160-77

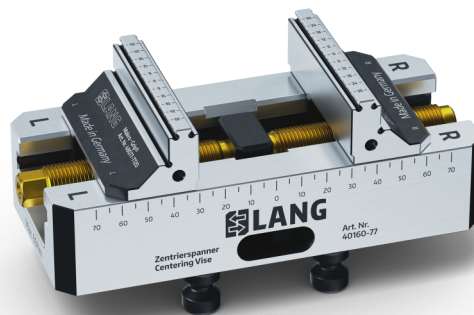

Clamping range	0 - 160 mm (0" - 6.3")
Dimensions	170 x 77 x 65 mm (6.69" x 3.03" x 2.56")
Clamping method	by form-fit / by friction
Workpiece shape	prismatic
Packaging Unit	1 Piece
Weight	3.6 kg (7.94 lbs)
Material	Steel

Makro-Grip® 77, 5-Axis Vise

jaw width 77 mm, clamping range 0 - 160 mm

Item No. 48160-77

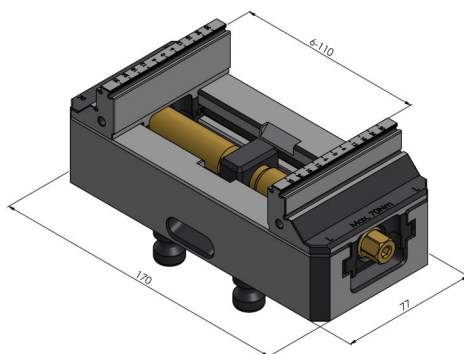
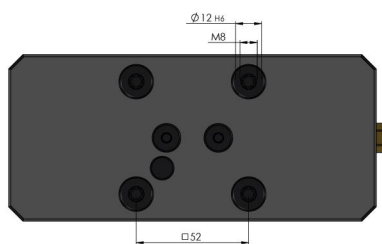

Makro-Grip® 77, 5-Axis Vise

jaw width 77 mm, clamping range 0 - 160 mm

Item No. 48160-77

