

Makro-Grip® 125, Spindle + Center Piece
spindle length 214 mm

Item No. 4825214

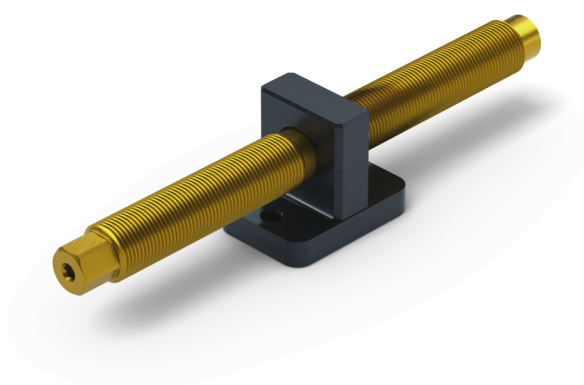

Spindle length	214 mm (8.43")
Thread pitch	M20 x 1.5
Workpiece shape	prismatic / cylindrical / asymmetrical
Packaging Unit	1 Piece
Weight	0.69 kg (1.52 lbs)
Material	Steel

Makro-Grip® 125, Spindle + Center Piece
spindle length 214 mm

Item No. 4825214

